

TO-630EB
 TO-600S
 TG-600H

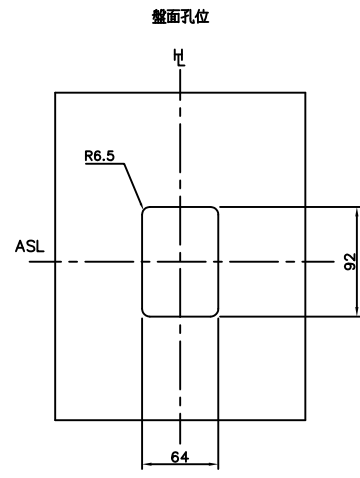
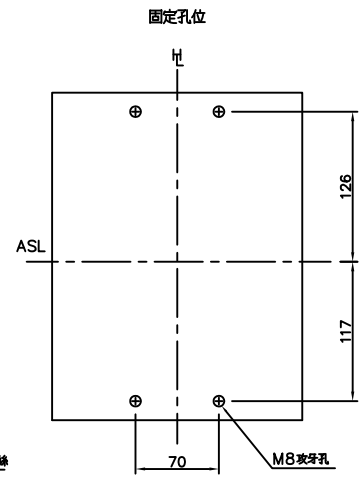
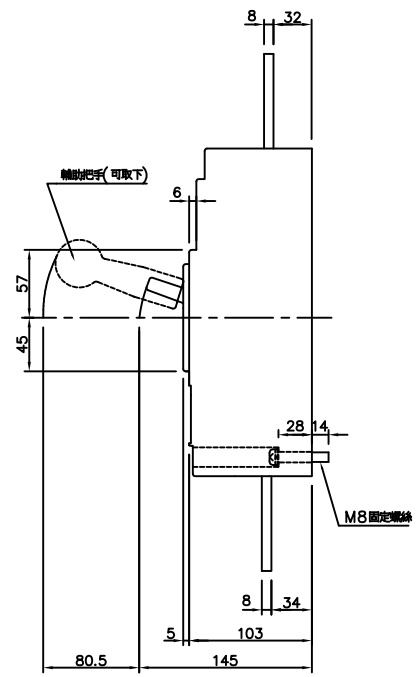
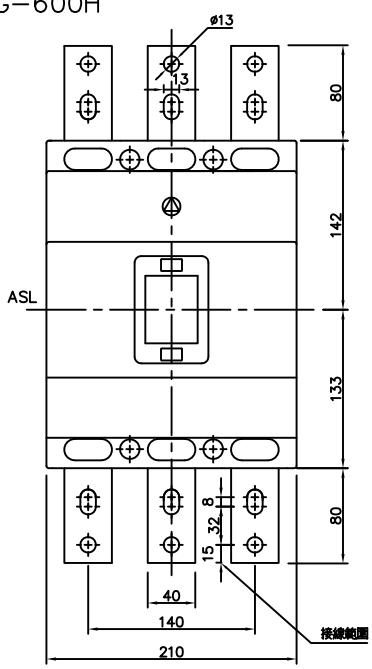

┆┆ : 把手桿中心線
 ASL: 配列基準線

※斷路器尺寸公差為±0.5mm; 盤面孔位公差為1.5mm.