

TCB-400S1 / S3 外型尺寸

(安裝 XPR8-C, 不用拆除端子板, 僅2P/3P機種適用)

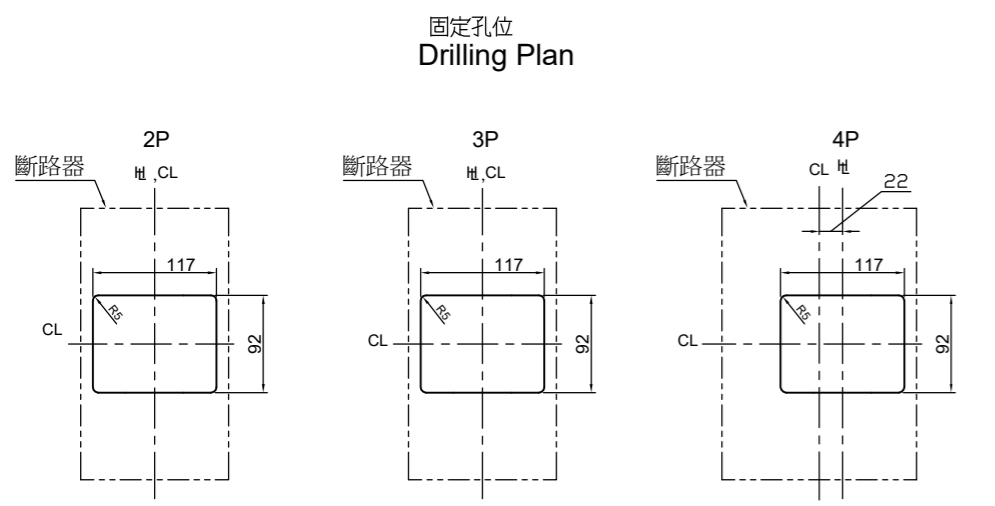
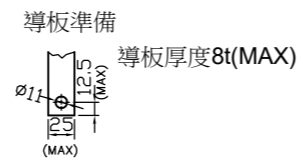
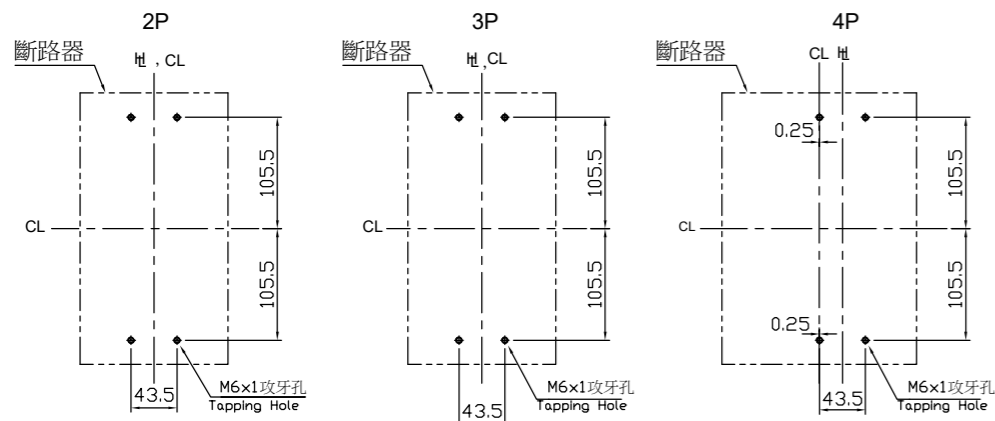
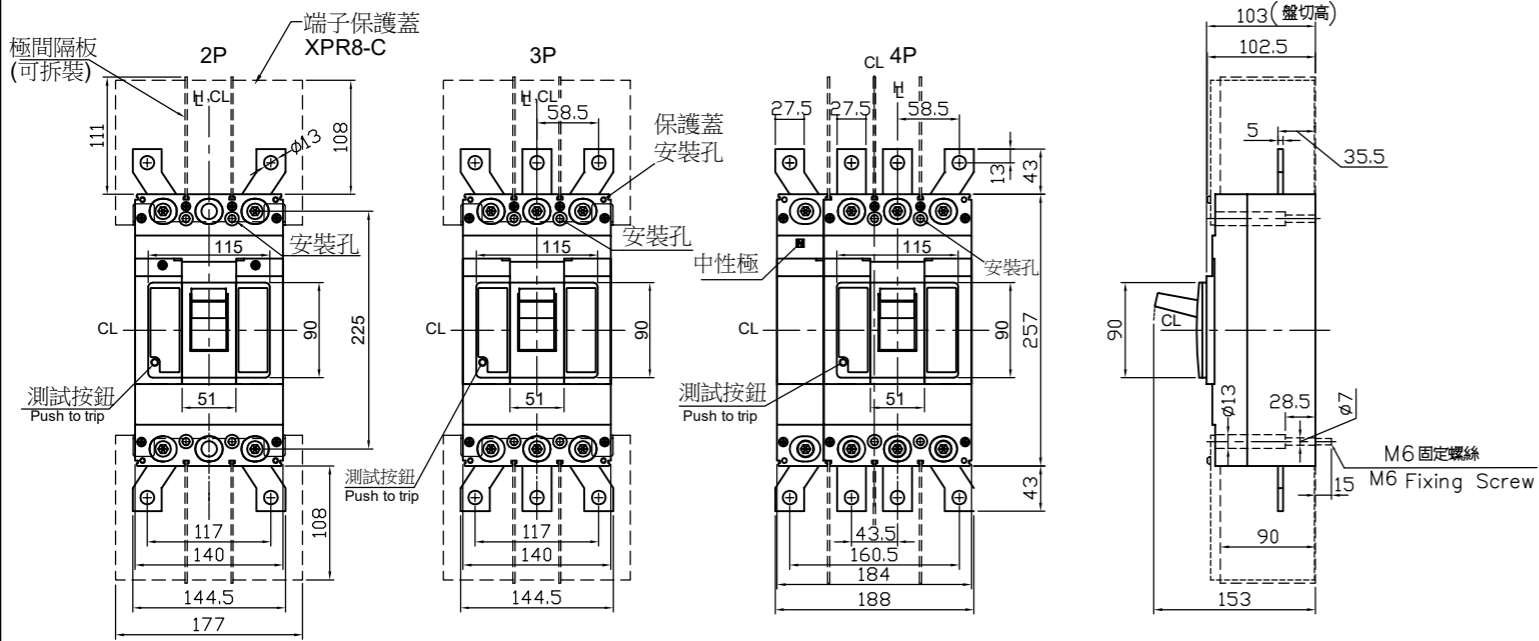

H: 把手中心線 Handle center line
 CL: 中心線 Center line
 * 斷路器尺寸公差±0.5mm
 Tolerance of Breaker Dimensin:±0.5
 * 盤面孔位公差1.5mm
 Tolerance of Panel Cutout

TCB-400S1 / S3 外型尺寸

(安裝 XPRP-C, XPRQ-C 要先拆除端子板)

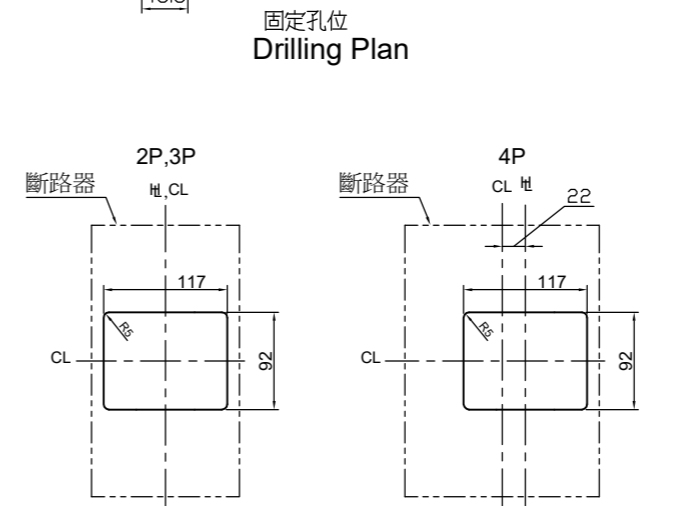
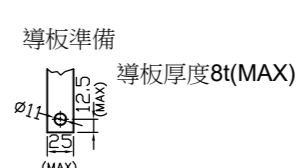
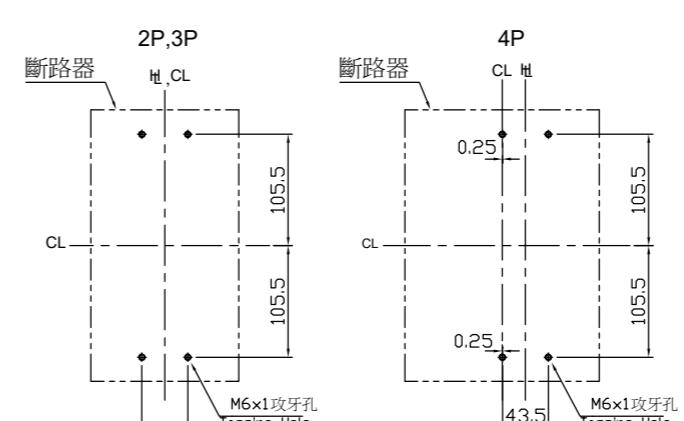
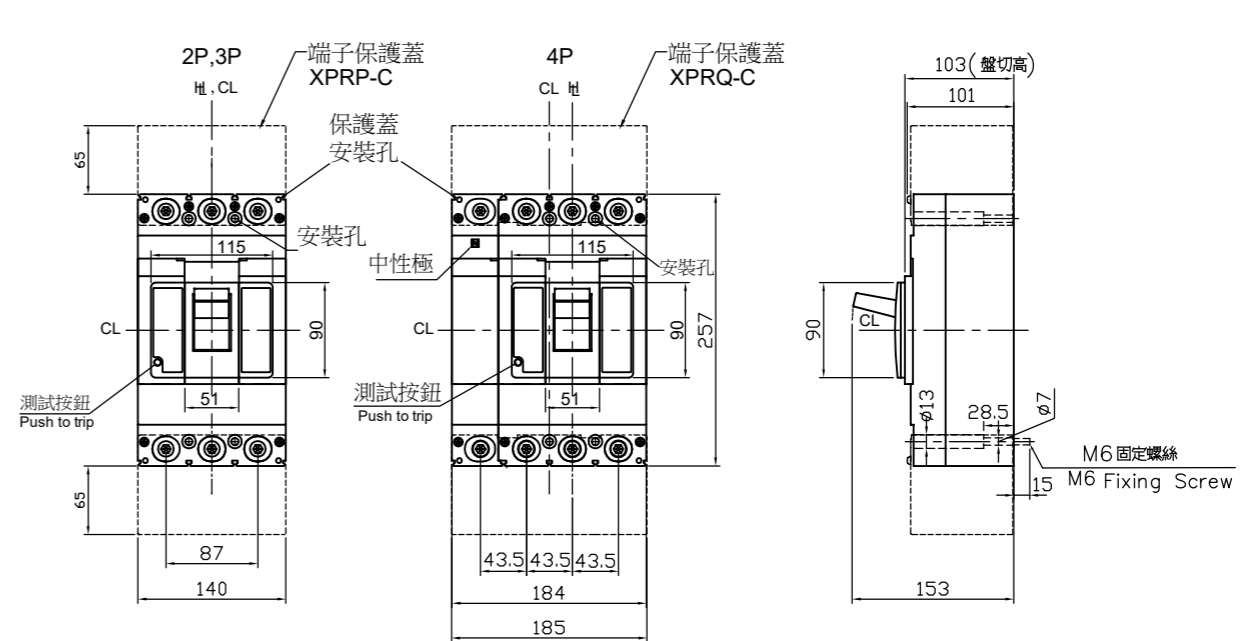

H: 把手中心線 Handle center line
 CL: 中心線 Center line
 * 斷路器尺寸公差±0.5mm
 Tolerance of Breaker Dimensin:±0.5
 * 盤面孔位公差1.5mm
 Tolerance of Panel Cutout