

TO-800EB
 TO-800S
 TG-800H

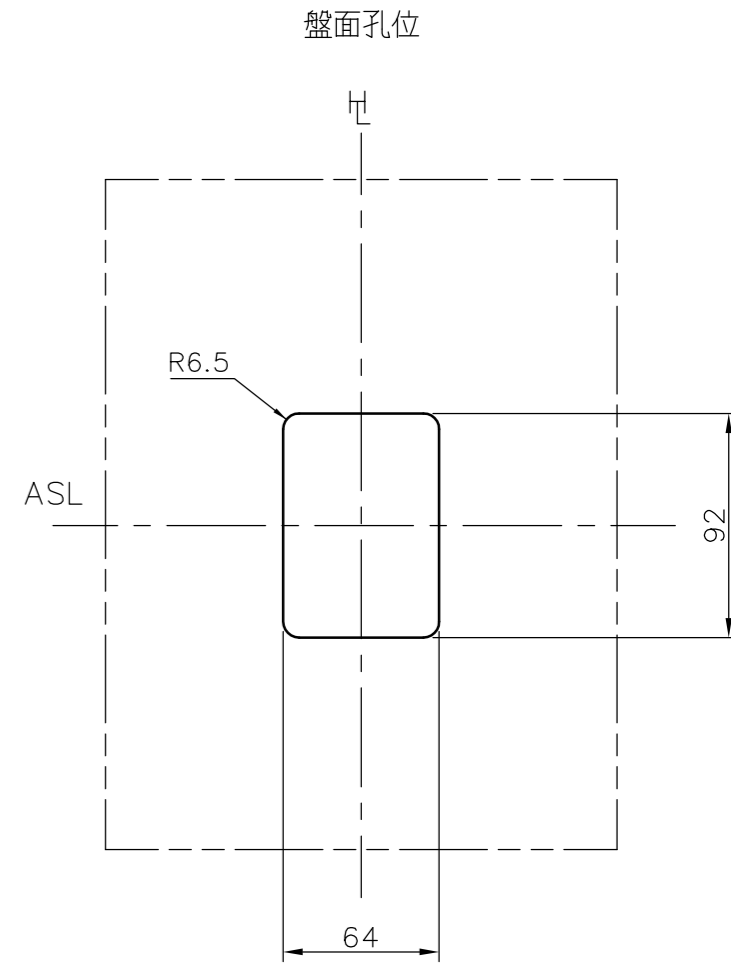
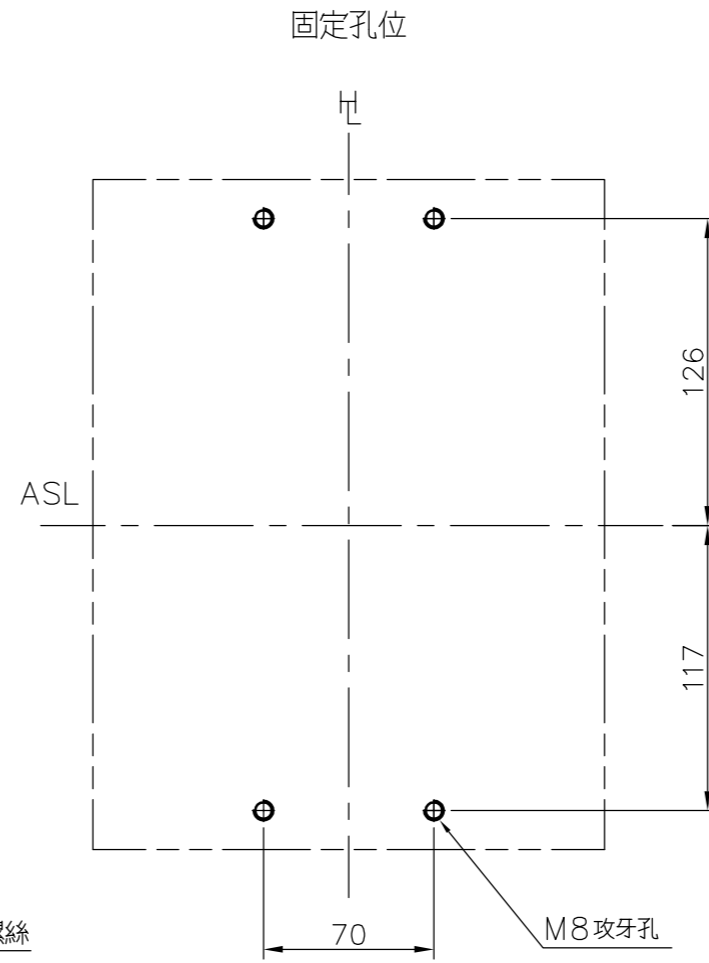
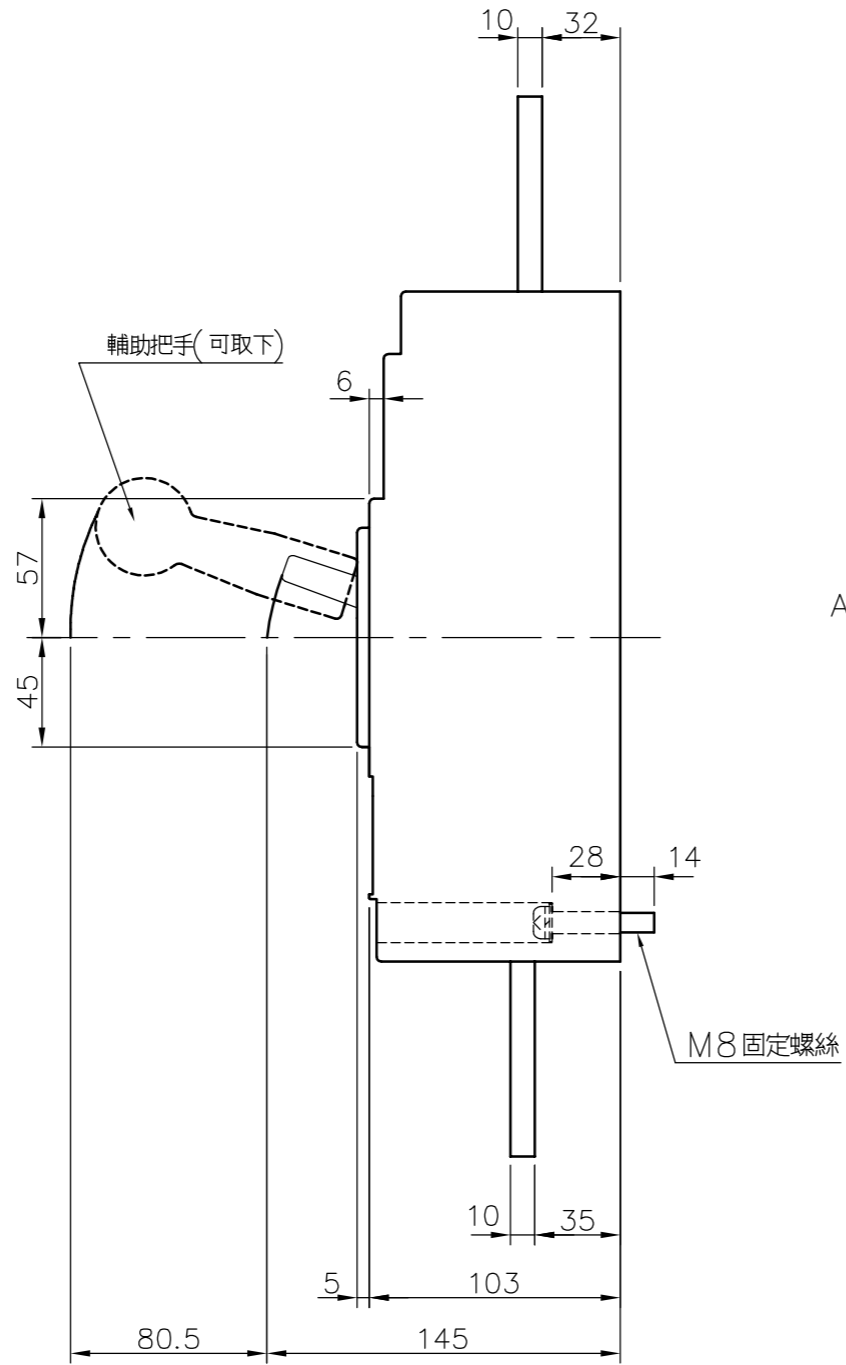
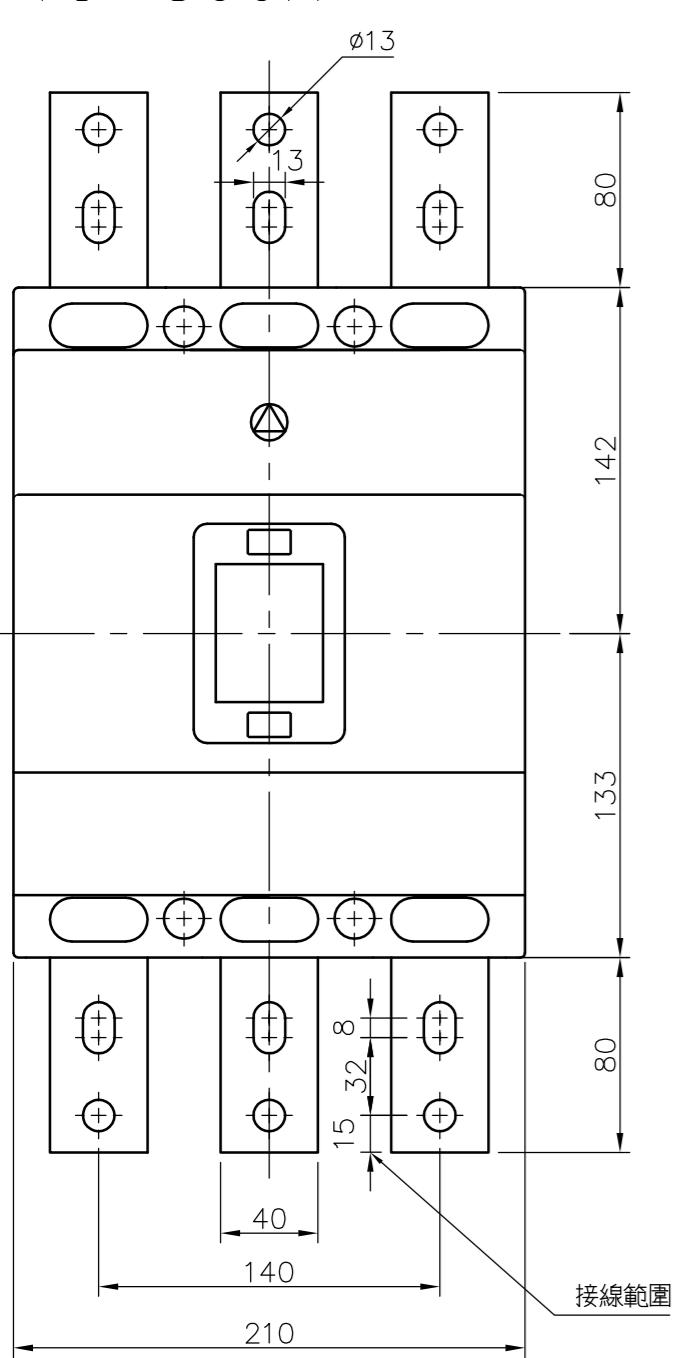

⌋ : 把手桿中心線
 ASL: 配列基準線

※斷路器尺寸公差為±0.5mm; 盤面孔位公差為1.5mm.