

漏電斷路器使用說明書

感謝您選用本公司漏電斷路器,在此請詳細閱讀說明書,以確保能正確使用此項產品。

安全注意事項

在進行施工、使用、檢查、維修的動作前,請務必熟讀此說明書,在此說明書中,將安全注意事項分成「危險」、「注意」兩個等級。

⚠️ **危險**: 在錯誤的操作下有可能導致受到嚴重的傷害甚至死亡。

⚠️ **注意**: 在錯誤的操作下有可能受到傷害或造成故障。

在標示「注意」、「危險」之表內記載的重要事項及可能產生的結果請務必熟讀及遵行。

使用注意事項

⚠️ 危險

- 漏電斷路器不能保護雙手握到帶電體引起的電擊。
- 接線端子於通電中請勿以手碰觸,以免觸電。

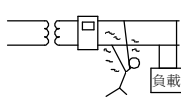

⚠️ 注意

- 電氣機器的接地端子必須要接地。
- 漏電斷路器自行跳脫時要先排除故障原因再投入,以防止發生觸電和火災。
- 測試按鈕每月作1次按下測試,確認動作正常,漏電斷路器如果不在TRIP(跳脫)位置,表示發生故障。
- 維護、檢修的工作須由具有專業知識的人實施,且須確認在上位的電源開關在OFF狀態,以防發生觸電。

施工注意事項

- 施工時各部份之詳細必要尺寸,請參照東元型錄

⚠️ 注意

- 電氣施工要由電氣專業人員負責。

- 配線作業時,要確定在無電狀態下工作。

- 漏電斷路器本體的接線請用額定電壓,以免不動作及故障。

- 高溫、潮濕、塵埃、腐蝕性氣體、振動、衝擊或其它異常環境下使用有可能會使漏電斷路器無法動作而導致觸電、火災。

- 漏電斷路器內部若有異物侵入時,有可能在發生線路故障時,無法正常跳脫而引起火災,故在施工中應避免水泥粉屑、鐵屑等粉屑掉入或雨水噴濺。

- 鎖線的螺絲要按表1的扭力值鎖緊,並且在開始使用後也要定期檢查,以免因螺絲鬆動造成火災。

表1. 端子螺絲的標準扭力

端子螺絲(種類及規格)	扭力值 N.m(Kgf.cm)
汎用型(M5)	2.3~3.4 (23~35)
汎用型(M6)	3.4~5.9 (35~60)
汎用型(M8)	4.9~6.9 (50~70)
內六角(M8)	7.8~12.7 (80~130)
內六角(M10)	13.7~22.5(140~230)
六角M10(六角頭)	22.5~37.2(230~380)
六角M12(六角頭)	40.2~65.7(410~670)

- 因內部線路設計問題,反接使用將造成只能短時間通電之線圈,於漏電動作時電源無法切斷而燒毀。且反接使用,將造成短路斷電能力降低。

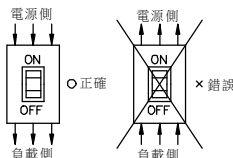

其它注意事項

- 漏電斷路器之把手在「ON」位置和「OFF」位置中間時顯示TRIP(跳脫)狀態,若要恢復ON狀態要先切到RESET(復歸)位置才能再投入到ON位置。
- 漏電斷路器的上蓋請勿拆下,若側邊封籤破損,則東元不負此品質責任。
- 漏電斷路器的背面絕緣板請勿取下,若取下;有發生接地故障的可能。
- 漏電斷路器上的跳脫按鈕,是為了確認跳脫機構動作功能是否能正常使用,在平時要切斷電源時請使用把手,以免減低漏電斷路器的壽命。

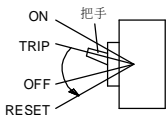

- 電線及導板規格要依額定電流選用,若使用低於標準的規格,將使漏電斷路器發生誤跳脫或過熱的現象。

- 電源側排氣口要確保有安全的絕緣距離,詳細尺寸參照下圖。

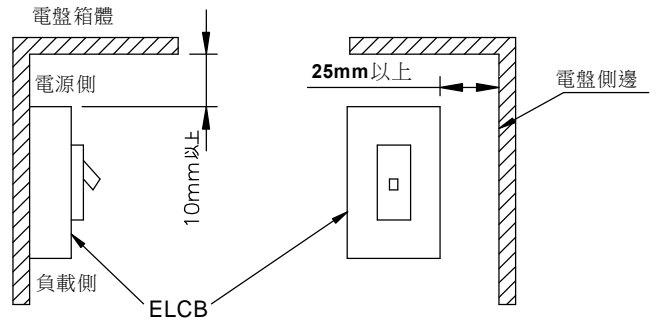

- 使用全磁式漏電斷路器時,請依下圖裝設角度補正額定電流值。

垂直	水平	逆水平	後斜15°	後斜45°	前斜15°	前斜45°
100%	120%	80%	105%	110%	95%	85%

- 使用時

- 使用環境條件

周圍溫度 -10°C ~ 40°C

相對溼度 85%以下

標高 2000m以下

周圍環境 無過量之水蒸氣、油蒸氣、煙、塵埃、鹽分、腐蝕性等物質存在之環境狀態下。

- 使用前請先做測試按鈕試驗以確認動作正常,連續使用時每月作一次測試按鈕試驗,以確保其功能正常。

- 漏電斷路器發生動作後,應先檢查回路事故原因,故障排除後再行投入。

- 絕緣電阻及耐電壓量測請參考表2進行。

表2. 絕緣電阻及耐電壓量測

量測位置	試驗項目	絕緣電阻		耐電壓試驗	
		ON	OFF	ON	OFF
把手狀態		○	○	○	○
相間	帶電體-大地間	○	○	○	○
	R-S	○	○	○	○
	S-T	○	○	○	○
間	R-T 電源側	△	○	×	○
	負載側	△	△	×	×
電源側及負載側端子間		—	○	—	○

○ 試驗可能

△ 試驗可能但測試值幾乎等於零。

× 試驗不可能

保養、檢查注意事項

- 為防止事故發生,應定期作維護、保養,使漏電斷路器於長期使用後仍能維持良好性能。

檢查項目	執行
1. 端子螺絲鎖電線時須確認有無鎖緊。	定期檢查端子螺絲有無鬆脫。
2. 異常溫度上升造成端子及接線部導體變色,並有可能使蓋和底座產生龜裂,應定期檢查。	以目視之方式確認端子及接線導體有無變色,並確認外殼有無破裂,若確認有問題應更換新品。
3. 漏電器表面及電源側端子部,應定期檢查,避免鐵屑、配線屑、油污等導電性異物侵入,造成發熱或不良之情形。	利用乾布擦拭或吹乾。
4. 把手之操作應平順,機構動作應正常,測試按鈕應定期做動作確認,以確保漏電器能正常動作。	長期投入操作,機構需塗佈潤滑劑以磨耗故障,接點之接觸電阻亦需保持穩定,以防異常發熱。

產品RoHS資訊

- 請到網站 <https://tecoie.teco.com.tw/download/rohs>

東元電機股份有限公司

新竹縣新竹工業區中華路15號

TEL:(03)5981711

EARTH LEAKAGE CIRCUIT BREAKER

Thank you for purchasing the TECO Earth Leakage Circuit Breaker.
Please read these instructions carefully to ensure correct use of the product.

Safety Notices

Be sure to read these instructions and other documents accompanying the product thoroughly to be familiar with the product handling, safety information, and all other precautions before mounting, using, servicing, or inspecting the product. In these instructions, safety notices are divided into "Warning" and "Caution" according to the hazard level:

Warning A warning notice with this symbol indicates that neglecting the suggested procedure or practice could result in lethal or serious personal injury.

Caution A caution notice with this symbol indicates that neglecting the suggested procedure or practice could result in moderate or slight personal injury and/or property damage.

Note that failing to observe caution notices could result in serious results under some situation.

Because safety notices contain important information, be sure to read and observe them.

Handling Precautions

Warning

- ELCB can not offer protection against the electric shock caused by touching both line and neutral at the same time.
- Please do not touch the wiring terminal when it is electrified lest causing electric shock.

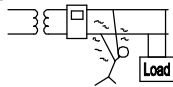

Caution

- The electrical equipment should be grounded.
- In case of tripping of the ELCB, the fault should be checked and eliminated before resetting the ELCB, or it may cause fire or electric shock.
- Probation of the test button should be executed once per month to see if the operation is normal. If the ELCB could not trip to OFF position while testing, it means malfunction.

Mounting Precautions

For detailed mounting dimensions, refer to the TECO catalogue.

Caution

- Electric work must be performed by persons who are qualified for electric work.
- Before doing electric wiring work on the product, open an upstream circuit breaker or the like to ensure that no voltage is applied to the product. Otherwise, electric shock may result.
- Please apply rated voltage to ELCB lest the ELCB will operate abnormally or breakdown.
- Do not place the product in such a area that is subject to high temperature, high humidity, dusty air, corrosive gas, strong vibration and shock, or other unusual conditions. Mounting in such areas could cause
- Be careful to prevent foreign objects (debris, concrete powder, iron powder, etc.) and rainwater from entering the product. These materials inside the product could cause a fire or malfunction.
- Regularly retighten terminal screws to the torque specified in Table 1 on the right. loose terminal screws could cause a fire.

Table 1: Terminal Screws and Tightening Torque (for Front-Connected Breaker)

Terminal Screws (Type and nominal diameter)	Tightening torque N · m [kgf · cm]
Pan head screw M5	2.3 ~ 3.4 [23 ~ 35]
Pan head screw M6	3.4 ~ 5.9 [35 ~ 60]
Pan head screw M8	4.9 ~ 6.9 [50 ~ 70]
Hex socket head screw M8	7.8 ~ 12.7 [80 ~ 130]
Hex socket head screw M10	13.7 ~ 22.5 [140 ~ 230]
Hex head screw M10 (with terminal bar)	22.5 ~ 37.2 [230 ~ 380]
Hex head screw M12 (with terminal bar)	40.2 ~ 65.7 [410 ~ 670]

- Reversing connection of line side and load side of a ELCB is not suggested, because it will lower the rate breaking capacity of the ELCB, and the coil will be burned for a long time connections.

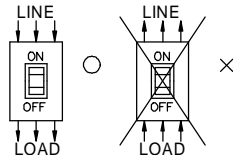

Other Precautions

- The operating handle being between the ON and OFF positions indicates the tripped state. To close the breaker, move the handle to the RESET position, then to the ON position.
- Do not open the breaker cover. Doing so could make our product quality assurance invalid.
- Do not remove the rear cover. Doing so could cause a ground fault.
- The trip button should be pressed for the solo purpose of checking the tripping mechanism and alarm switch (optional) for normal operation. Do not use this button to open the breaker. Doing so will shorten the breaker's service life.

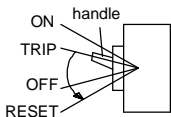

- When mounting the product, use wires or copper strips, the cross sectional areas of which accommodate the rated current of the product. Using them with smaller cross sectional areas may cause false tripping and overheating.
- Do not block the arc gas vents of the product to ensure adequate arc space (insulation distance). Blocking these vents could result in failure of current interruption.

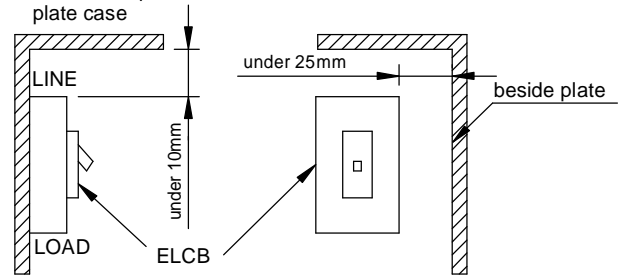

- Please compensate the rating current about installing angle as shown.

VERTICAL	HORIZONTAL	REVERSE HORIZONTAL	REAR INCLINATION 15°	REAR INCLINATION 45°	FRONT INCLINATION 15°	FRONT INCLINATION 45°
100%	120%	80%	105%	110%	95%	85%

- use conditions

- The operational conditions:

Ambient temperature -10°C ~ 40°C

Relative humidity below 85%

Altitude under 2000m

Environment not with overdose of steam, smoke, fog, dust, salty matter, and corrosive materials.

- Please check if the ELCB is in good condition by a prior probation of test button. Probation of the test button should be executed once per month to make sure if the ELCB works normally.

- In case of tripping of the ELCB, checking the fault point at first is suggested. Fault condition should be eliminated before resetting of ELCB.

- Please execute the resistance of the insulation against impulse voltages measure referring to the information in table 2.

Table 2. resistance of the insulation against impulse voltages measure

measure position		test item	resistance of insulation		impulse voltages	
			ON	OFF	ON	OFF
handle stage			○	○	○	○
LINE-EARTH			○	○	○	○
Phase	R - S		○	○	○	○
			○	○	○	○
	S - T		○	○	○	○
			○	○	○	○
R-T	LINE	△	○	×	○	
	LOAD	△	△	×	×	
Between line and load			—	○	—	○

○ could be test

△ could be test but test data nearly zero.

× impossible test

Maintenance Precautions

ELCB must be maintained regularly to make sure the ELCB works normally, even in a long term usage.

	Checking Point	Measures
1.	Make sure if the terminal screws are well fastened while wiring.	Check if the screw is loose periodically.
2.	Abnormal temperature rise might brownish terminals or living parts of wiring, and it might cause brownish chaps of the ELCB cover or base. This should be checked periodically.	Check if terminals or living parts of wiring turn brown by visual observation, and make sure if the frame chaps. Changing a new ELCB is suggested if the ELCB is of such problems.
3.	Check the outlet of ELCB surface or terminal side to avoid intrusion of conductive foreign body e.g. iron filings, greasy dirt.	Use dry cloth or blower to clean the ELCB.
4.	Check if the handle and the mechanism of ELCB could operate smoothly and execute probation of the test button periodically to ensure that ELCB could work normally.	If the ELCB would run for a long term, the mechanism part should be smeared with lubricant lest it wear down. Make sure the contact resistance of contacts could maintain stable, or it might cause abnormal temperature rise.

Product RoHS Information

Download from the site

<https://tecoie.teco.com.tw/download/rohs>

TECO ELECTRIC & MACHINERY CO., LTD.

15 Chung-hwa Rd., Hsinchu Industrial Park, Taiwan, R.O.C.

TEL: 886-3-5981711

W www.teco.com.tw