



96\*96mm

# TMM 20 / 70 Series

Multifunction Power Meter

# TMM-20

Multifunction Power Meter 96\*96



## Description

The TMM-20 series Multifunction Power Meter provide high accuracy measurement, display and communication (Modbus RTU) of all electrical and power quality parameters, including harmonic measurement THD(Total Harmonic distortion)

Provides electricity bill ratio (Cost) and carbon dioxide ratio (Co2) set can show cumulative electricity bills and carbon emissions, and suitable for the installation in the power management of remote communication, such as the use of demand.

## Meter Selection Guide

Measurement items and functions			TMM-20
Battery parameters	Voltage	$V_{12}, V_{23}, V_{31}, V_{LN\_Avg}$ $V_1, V_2, V_3, V_{LN\_Avg}$	●
	Current	$I_1, I_2, I_3, I_{Avg}, I_N$	●
	Active Power	$P_1, P_2, P_3, \sum P$	●
	Reactive Power	$Q_1, Q_2, Q_3, \sum Q$	●
	Apparent Power	$S_1, S_2, S_3, \sum S$	●
	Power Factor	$PF_1, PF_2, PF_3, PF_{Avg}$	●
	Frequency	Hz	●
	Active Energy	WH Total	●
	Reactive Energy	QH Total	●
	THDNoltage	$THD_{V12}, THD_{V23}, THD_{V31}, THD_{V_{Avg}}$	●
	ITHD/Current	$THD_{I1}, THD_{I2}, THD_{I3}, THD_{I_{Avg}}$	●
	Communication Port	Modbus RTU mode	●
	Cumulative electricity bill	Cost	●
	Emission Total Co2	Co2	●
	Date and Time	Year, Month, Day, Hour, Minute, Second	●

## Technical Specification

Function	Parameter	Specification
Input	Measurement	True RMS measurement
	Sampling	128 point/cycle
	Metering system	1P2W, 1P3W, 3P3W, (1/2/3CT), 3P4W(1/3CT)Balance/Unbalance
	Input range	Voltage : 60~600VLL PT primary ratio: 100~500,000V PT secondary ratio: 100~600V Current: 0~5A,(optional:0~1A) CT primary ratio : 5~10,000A Frequency: 45~65Hz
	Overload capacity	Voltage : 2x rated continuous ; 2500V/1s Current : 2x rated continuous ; 20x rated 1s
	Input burden	Voltage : <0.2VA ; Current : <0.1VA
Power Quality	THD	Total harmonic distortion for voltage and current
RS 485 Communication (option)	Protocol	Modbus RTU mode
	Baud rate	1200/2400/4800/9600/19200/38400
	Data bits	8 bits
	Parity	None / Even / Odd
	Stop bits	1 or 2
	Address	1~255
	Distance	1200M max
	Terminate resistor	120~300Ω/0.25W(typical:150Ω)
Automatic correction	RS485	
Safety	Isolation	AC 2kV, 50/60Hz, for 1min. between Power/Input/Output/Case
	Surge test	3KV, 1.2 x 50 μsec. Common mode & differential mode
	Insulation resistance	≥100MΩ DC 500Vdc
	EMC	EN 55011:2002; EN 61326:2003
	Safety(LVD)	EN 61010-1:2001
Environmental Conditions	Operating Temp	0~60 °C
	Humidity rating	5~95 %RH, Non-condensing
	Temp. coefficient	≤100 PPM/°C
	Storage Temp	-10~70 °C
Power Supply	Degree of protection	Front panel: IEC 529 (IP50) ; Housing: IP20
	Range	AC 85~264V/DC 100~300V
	Power consumption	AC:≤10VA @230V/DC≤3W
Mechanical Structure	Memory storage	By EEPROM
	Dimensions	96mm(W) x 96mm(H) x 71mm(L)
	Panel cutout	90mm(W) x 90mm(H)
	Material	ABS, Black (with fire-retardant)
	Mounting	Panel mounting
	Wire terminal	PA66 (UL 94V-0) Voltage/Current input: AWG:26~10/0.5~4.0mm² Screw Torque Value:M3/8.0kgf.cm (Max) Others input: AG:28~16/0.5~1.5mm² Screw Torque Value:M2/2.04kgf.cm (Max)
	Weight	<400g

Accuracy & Resolutions

Paramter	Accuracy	Resolution	Measurement Range
Voltage	0.25%	0.1V	40.0 ~400.0 Vac (V <sub>LN</sub> )
Current	0.25%	0.001A	1%~ 120% CT rating current
Neutral Current	1.0%	0.001A	1%~ 120% CT rating current
Active Power	0.5%	1W	-999999999~999999999W
Reactive Power	0.5%	1Var	-999999999~999999999Var
Apparent Power	0.5%	1VA	0~999999999VA
Power Factor	0.5%	0.001	± 1.000
Frequency	0.2%	0.01Hz	45~65Hz
Active Energy	0.5%	0.1kWh	0~99999999.9 kWh
Reactive Energy	0.5%	0.1kVarh	0~99999999.9 kVarh
Apparent Energy	0.5%	0.1kVAh	0~99999999.9 kVAh
Individual Harmonic	1.0%	0.1%	0~1000 %

Technical Specification

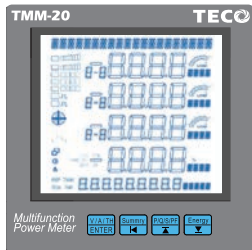

Backlight on time 1~15Min ("0" is always light)

Display LCD65(Wx58(H))mm ; White backlight ; Blue wording  
Visible under direct sunlight  
LCD LED : Backlight on time 1~15Min ("0" is always light)

Measured value display Upper row 20 digits : Display date, time  
8888 4 Digitsx 4 rows, Display value  
88888888  
8 Digits x 1 row, Display Energy parameters  
Rs485 communication status : 2 square status  
icons Display Master and Slave status :

Load status indication IND : load is inductive  
CAP : load is capacitive  
LOAD% : Display load percentage  
↖ : Display load quadrant

Additional symbols for measured values

- R-B, B-C, C-A : When on, value showing Line-Line
- R, B, C : When on, value showing in Phase
- N : When on, value showing in Neutral
- Total : When on, value showing Total value
- Avg : When on, value showing Average
- MAX MIN : When on, value showing Line-Line
- THD : When on, value showing max/min values
- V, I, A, kW, MVar : Display metering data Unit

Display load quadrant 0.5sec

Control button: 4 Down Key

- [V/A/I] [ENTER] Enter Key/ Voltage /Current display page
- [Sum] Shift Key / Main electric parameters display page
- [P/DIS/PR] Up Key / Electric parameters display page
- [Energy] Down Key/ Energy parameters display page

Passwords: 4 digits passwords : Range : 0000~9999

Dimensions

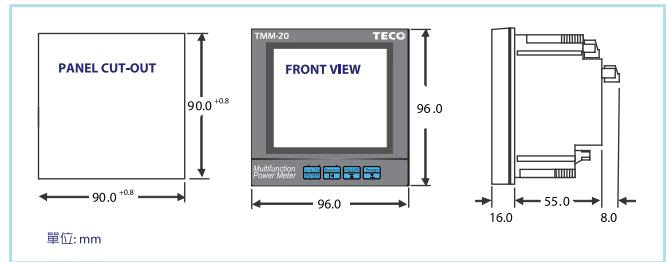

Installation

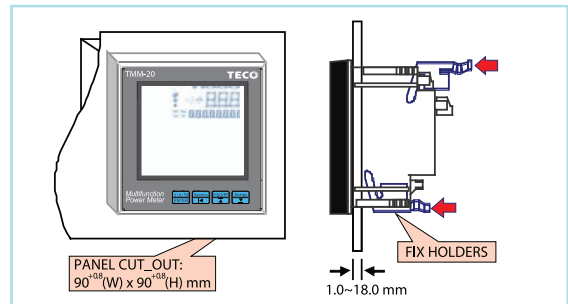

Application Field

- Power monitoring for motor control panels.
- Power monitoring of the distribution board.
- Power management and electricity separation system.
- Power quality analysis.



RS-485 Communication port

RS485 / Auxiliary supply (Terminal2)  
Wire terminal: AWG28~16(0.5~1.5mm<sup>2</sup>)

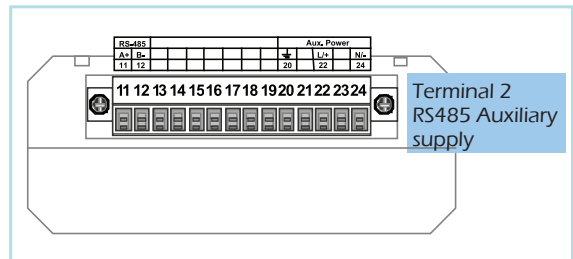

RS-485 Communication

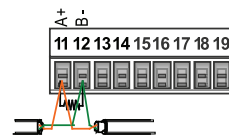

Distance: 1200M max  
Terminate resistor.  
120~300Ω/0.25W  
(typical:150Ω)

Connection diagram

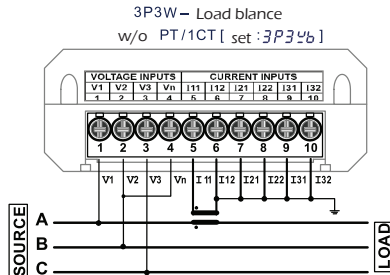
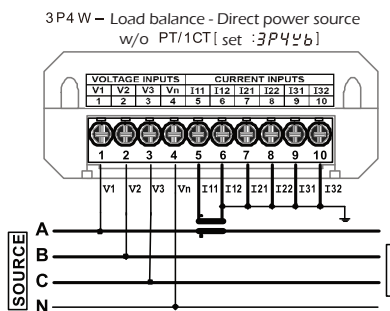
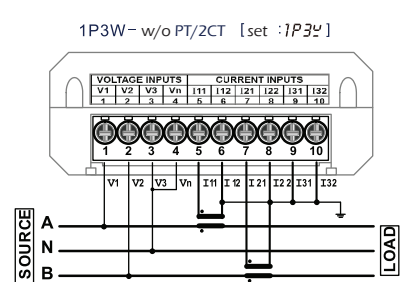
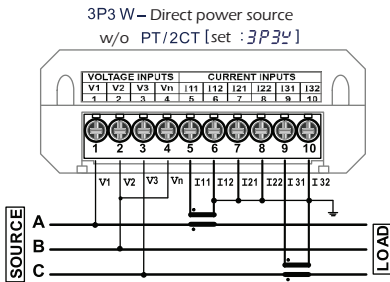
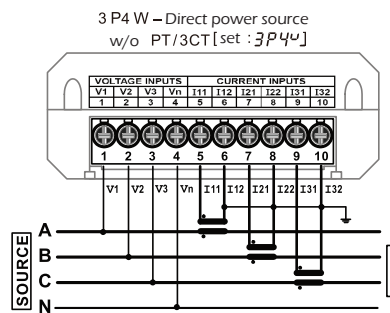
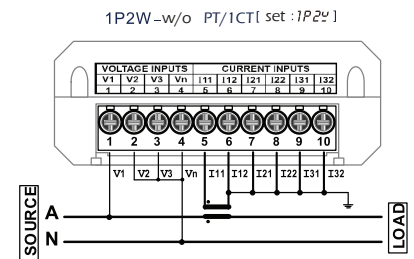
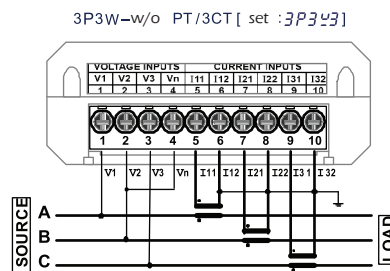
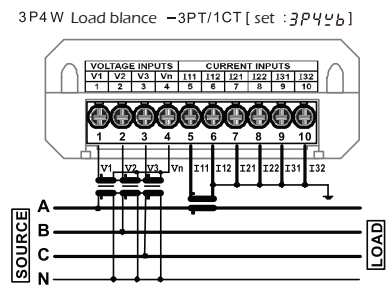
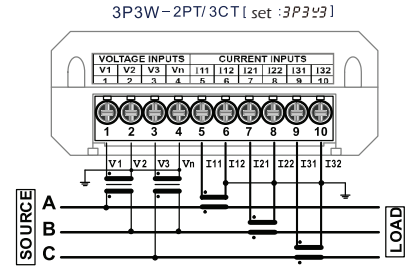
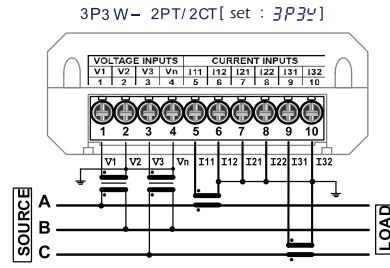
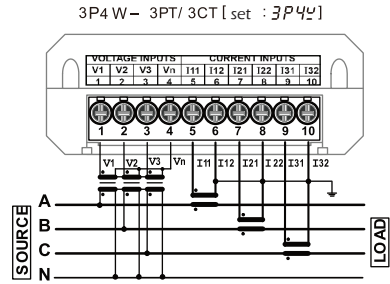



# TMM-70

## Multifunction Power Meter 96\*96



### Description

TMM-70 multifunction power analyzer provide high accuracy single phase and three-phase energy measuring and displaying, energy accumulating, power quality analysis, data logging and data communication.

TMM70 series meters are able to measure bidirectional, four quadrants kWh and kVarh. It provides maximum/minimum records for power usage and power demand parameters.

Hardware standard built in a RS485 Modbus communication port , 4 Digital inputs, 2 Relay outputs, LCM and 2 MB flash for data-logging. In addition , also provide TOU , voltage and current THD, harmonics up to the 31st and auto wiring change via software.

### Meter Selection Guide

Power parameters	Voltage	$V_{12}, V_{23}, V_{31}, V_{LL,Avg}$ $V_1, V_2, V_3, V_{LN,Avg}$
	Current	$I_1, I_2, I_3, I_{Avg}, I_N$
	Active Power	Four quadrants $P_1, P_2, P_3, \sum P$
	Reactive Powe	Four quadrants $Q_1, Q_2, Q_3, \sum Q$
	Apparent Power	$S_1, S_2, S_3, \sum S$
	Power Factor	$PF_1, PF_2, PF_3, PF_{Avg}$
	Frequency	Hz
	Acive Energy	Wh Imp Wh Exp Wh Total Wh Net
	Reactive Energy	Varh Imp Varh Exp Varh Total Varh Ne
	Apparent Energy	VAh
	THD Noltage	$THDV_{V12}, THDV_{V13}, THDV_{V31}, THDV_{Avg}$
	THD/Current	$THD_{I1}, THD_{I2}, THD_{I3}, THD_{Avg}$
	Individual harmonic	2nd~31st Individual harmonics
	Demand	Current Demand, Power Demand
	Max. Demend recording	Max. Demand of Current & Power and time stamp
	Maxi/Min Values	Maxim um / Minimum values and time stamp
	External Control	D11 D12 D13 D14
	Digital Ouput	DO1
	Relay Output	RO1
	Time of Use	4 time zones, 8 periods
Date and Time	Year, Month, Day, Hour, Minute, Second	

### Technical Specification

Function	Paramter	Specification
Input range	Measurement	True RMS
	Input range	Voltage:40~600V L-L PT Primary side ratio:100~500,000V PT Secondary side ratio:50~600V Current:0~5A,(Optional:0~1A) CT primary ratio:5~10,000A Frequency:45~65Hz
	Overload capacity	Voltage:2x rated voltage continuous;2500V, 1sec Current:2x rated current continuous;20x rated current 1sec
	Input burden	Voltage:<0.2VA; Current:<0.1VA
Power Quality	THD	Total harmonic distortion for voltage and current
	Individual harmonic	2nd~31st individual harmonics for voltage and current
Relay Output(RO)	Relay capacity	Dual SPST(1a);5A/250Vac;5A/30Vdc
	Relay action mode	Hi/Lo/Hi. Hold/Lo. Hold/DO
	Set points	UP to DI parameters of power and demand for alarm
External Control Input (ECI)	Input capacity	4 channels DI input;mechanical contact open collector input are available
	Input function	Can set up for DI/Demand reset/Max. Demand reset/ Energy values reset/Max. and Min. Values reset/Relay reset
	Debouncing time	0~99(x8mS) programmable
Digital Output (DO)	Output capacity	Open collect(O.C.);Output:30Vdc, 30mA(max)
	Output frequency	1000Hz(max)
	Pulse divider	1~9999(1 Pulse=0.1kWh;if set 100,1 Pulse=10.0kWh)
	Pulse width	0~5000(x4mS), 0 is duty cycle 50%
	Test pulse output	3200 Pulse/1kWh, Duty cycle 50%
	Calculation method	Block/Sliding
Time of Use (TOU)	Time zones	1~4 zones per year
	8 periods	1~8 each time zone (The sharp, peak, valley and tariff can be specified for each period.)
	Parameters of TOU	AE-Imp, AE-Exp, AE-Total, RE-Imp, RE-Exp, RE-Total, SE, SE-Total
Data Logging	Holiday setting	The date timetable of holiday for 5 years can be set individually or set on the same holiday for 5years.
	Setting	Load setting from previous saved file or set according to needs, Time interval from 1~32767 for second, minute, hour or day, depend on value record needs.
	Sampling	128 point/Cycle
	Power system	1P2W, 1P3W, 3P3W, (1,2,3CT), 3P4W(1,3CT); Balance/Unbalance
RS485 communication	Memory storage	Day, Hour, Minute, Second 2MB Flash ROM
	Protocol	RS485 Modbus RTU mode
	Address	1~247
	Baud rate	1200/2400/4800/9600/19200/38400
	Parity	None/Even/Odd
	Data bits	8 bits
	Stop bits	1 or 2
	Distance	1200M max
Terminate resistor	120~300Ω/0.25W(typical:150Ω)	

Front panel

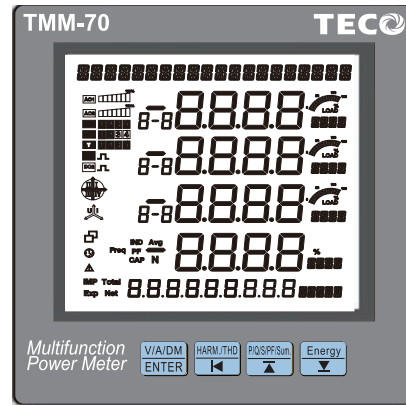

Accuracy & Resolutions

Parameter	Accuracy	Resolution	Measurement Range
Voltage	0.2%	0.1 V	40.0~400.0Vac(V <sub>LN</sub> )
Current	0.2%	0.001A	1%~120% CT Rating Current
Neutral Current	1.0%	0.001A	1%~120% CT Rating Current
Active Power	0.5%	1W	-99999999~99999999W
Reactive Power	0.5%	1Var	-99999999~99999999Var
Apparent Power	0.5%	1VA	0~99999999VA
Power Factor	0.5%	0.001	±1.000
Frequency	0.1%	0.01Hz	45.00~65.00Hz
Active Energy	0.5%	0.1kWh	0~99999999.9kWh
Reactive Energy	0.5%	0.1kVarh	0~99999999.9kVarh
Apparent Energy	0.5%	0.1kVAh	0~99999999.9kVAh
THD	1.0%	0.1%	0~100.0%
Individual Harmonic	1.0%	0.1%	0~100.0%
Unbalance	0.5%	0.1%	0~300.0%

Display

LCD 65 (W) x61 (H)mm : White backlight  
Backlight delay time : 0-15 min ( "0" is always on)

Description

Twenty digits in the top of display area: Display mode indication.  
Four line of 8 digits in the metering area : Display metering data such as Voltage, current, power, power factor, frequency, unbalance, etc.  
Four line of 8 digits in the metering area :Display metering data unit.  
Three line 8-8 digits:1, 2, 3 for 3 phase ;1-2, 2-3, 3-1 for 3 phase line to line.  
Nine 8 and five digits:Display energy data and unit.  
Also display real time o'clock.

Dimensions

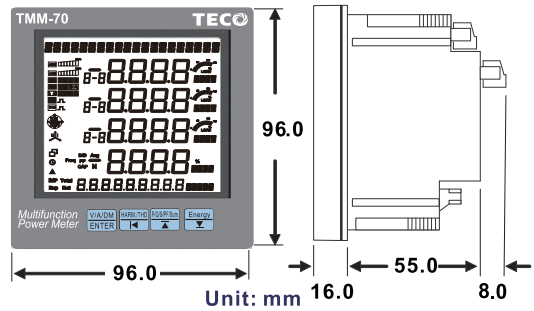

Installation

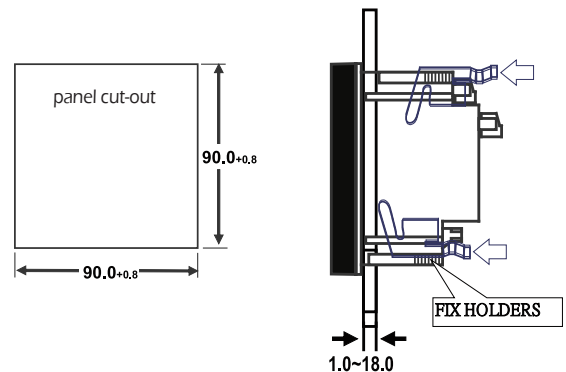

Function	Parameter	Specification
Environmental Characteristics	Operating Temp	0~60°C
	Humidity rating	5~95%RH, Non-condensing
	Temp. coefficient	≤100PPM/°C
	Storage Temp.	-10~70°C
	IP Enclosure	Front panel:IEC 529 (IP50); Housing:IP 20
Power Supply	Range	AC 85~264V; DC 100~300V
	Power consumption	AC:≤10VA @230V/DC:≤3W
Safety	Isolation	AC 2KV, 50/60Hz, for 1min, Between Power/Input/Output/Case
	Isolation resistance	≥100Ω @500V <sub>dc</sub>
	EMC	EN 61326:2006
	LVD	EN 61010-1:2010
Mechanical Characteristics	Dimensions	96mm(W) x 96mm(H) x 79mm(L)
	Panel cutout	90mm(W) x 90mm(H)
	Material	ABS, Black (with fire-retardant)
	Mounting	Panel Mounting
	Weight	≤450g
	Wire terminal	PA66 (UL 94V-0) Voltage/Current input: AWG:26~10/0.5~4.0mm <sup>2</sup> Screw Torque Value:M3/8.0kgf.cm (Max) Others input: AG:28~16/0.5~1.5mm <sup>2</sup> Screw Torque Value:M2/2.04kgf.cm (Max)

Connection diagram

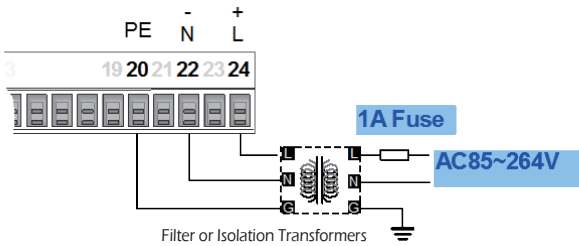
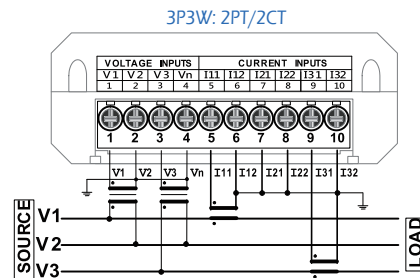
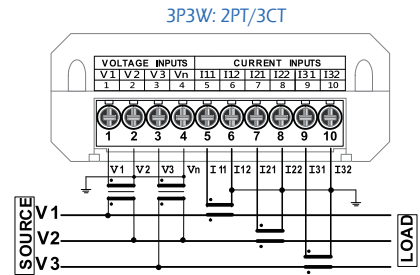
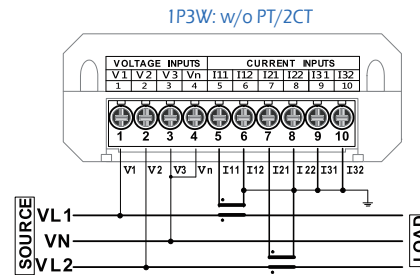
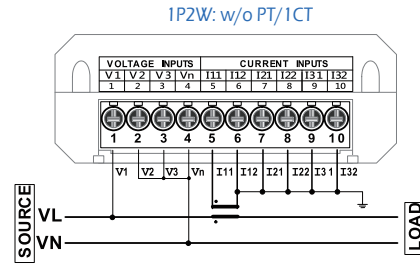
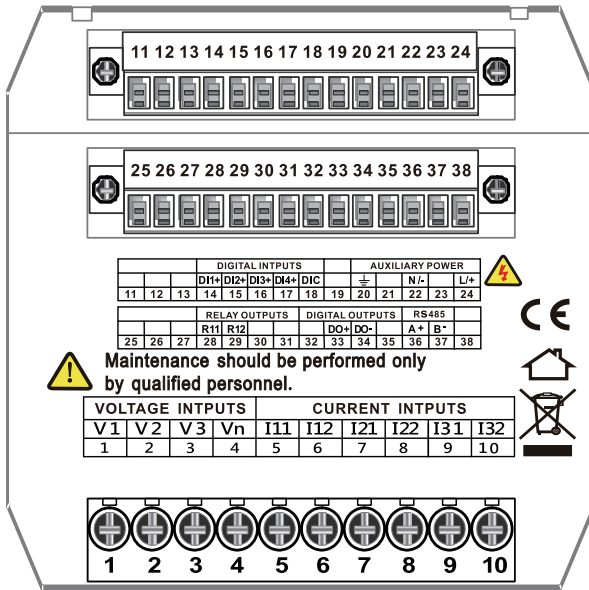

Dimensions

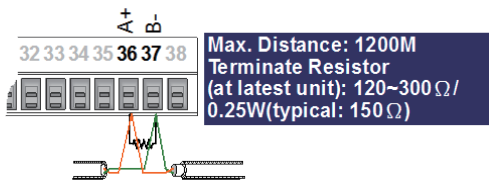

Application Field

- Power monitoring for motor control panels.
- Power monitoring of the distribution board.
- Power management and electricity separation system.
- Power quality analysis.



External Control Input (ECI)

Wire terminal : AWG22-28(0.5-1.5mm<sup>2</sup>)

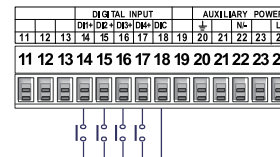

Relay Output (RO) / Digital Impulse Output (DO)

Wire terminal : AWG22-28(0.5-1.5mm<sup>2</sup>)

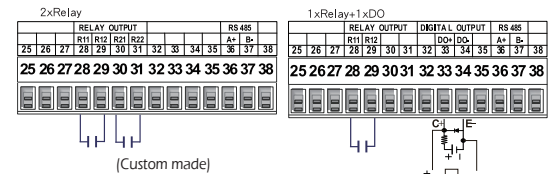

Connection diagram

3P3W: 2PT/1CT

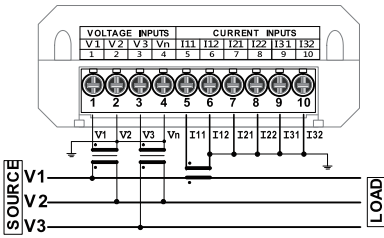

3P3W: 2PT/2CT  
\*note 1

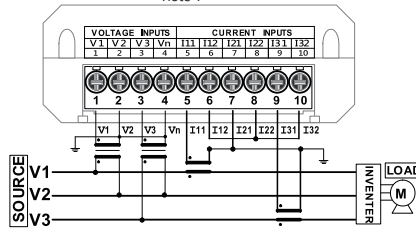

3P4W: 3PT/3CT

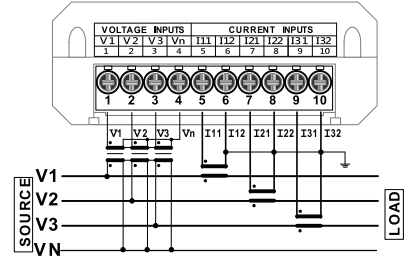

3P3W: w/o PT/3CT

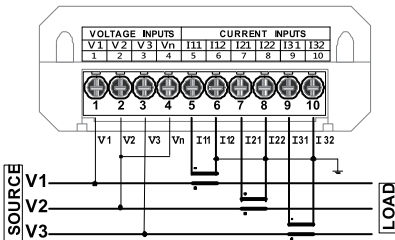

3P3W: w/o 2PT/2CT  
\*note 1

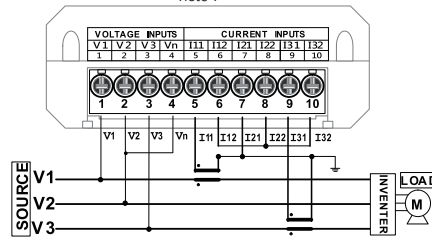

3P4W: w/o PT/3CT

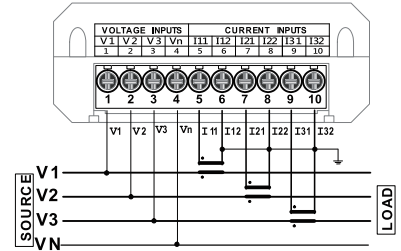

3P3W: w/o PT/2CT

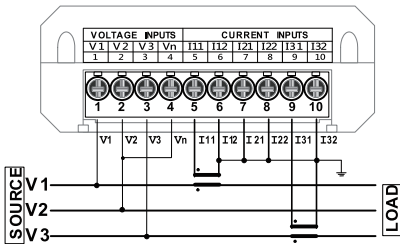

3P4W: 3PT/3CT

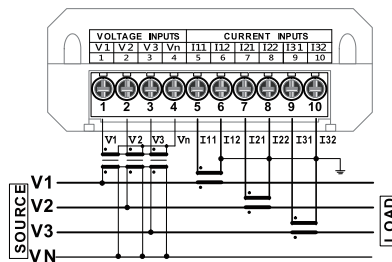

3P4W: w/o PT/1CT

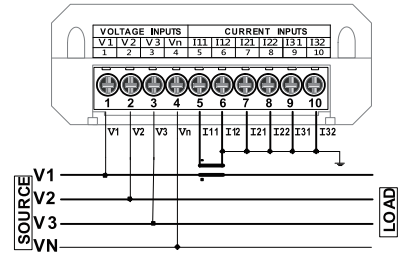

3P3W: w/o PT/1CT

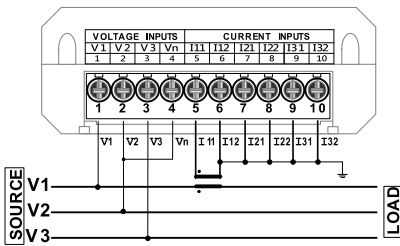

3P4W: 3PT/1CT

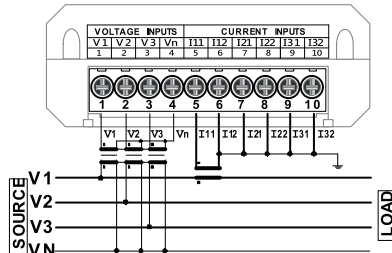

\*note 1: This CT connection is available use for inverter load or normal load situation.



TECO Electric & Machinery Co., Ltd.

5F, No. 19-9, SanChong Rd., Nan-Kang, Taipei 11501, Taiwan (R.O.C.)  
Tel 886-2-26553333 ext 3674



More information



<https://tecoie.teco.com.tw/>

Ratings and specifications covered in this brochure may be subject to change without notice.

GM-47-00 2023-05-09